

INSTALLATION INSTRUCTIONS

Air Conditioner

Panasonic[®]

This air conditioner uses the refrigerant R32.

Model No.

| Indoor Units | | | | |
|--------------|-------------------|------------|------------|------------|
| Type | Rated Capacity | 36 - 50 | 60 - 71 | 100 - 140 |
| | Indoor Units Type | 3650 | 6071 | 1014 |
| T3 | Ceiling | S-3650PT3E | S-6071PT3E | S-1014PT3E |



<https://eu.datanavi.ac.smartcloud.panasonic.com/documents/>



ENGLISH

FRANÇAIS

ESPAÑOL

DEUTSCH

ITALIANO

NEDERLANDS

PORTUGUÊS

ΕΛΛΗΝΙΚΑ

БЪЛГАРСКИ

TÜRKÇE

ENGLISH

Read through the Installation Instructions before you proceed with the installation. In particular, you will need to read under the "IMPORTANT!" section at the top of the page. This booklet mainly mentions the safety-related regulatory matters. Regarding the contents of the installation, please scan the matrix two-dimensional (2D) barcode and refer to the detailed manuals. Panasonic will accept no responsibility for any accident or damage that occurs as a result of such improper installation in any way not described in the detailed manuals. Also, malfunction caused by incorrect installation is not covered by the product warranty.

FRANÇAIS

Lisez les instructions d'installation avant de commencer l'installation. En particulier, vous devez lire la section « IMPORTANT! » en haut de la page. Ce livret décrit principalement des questions réglementaires et de sécurité. Pour des explications sur l'installation, veuillez scanner le code-barres 2D de la matrice et vous reporter aux manuels détaillés. Panasonic n'assume aucune responsabilité pour tout accident ou dommage qui se produit à la suite d'une mauvaise installation effectuée d'une manière qui n'est pas décrite dans les manuels détaillés. De plus, le dysfonctionnement provoqué par une installation incorrecte n'est pas couvert par la garantie du produit.

ESPAÑOL

Lea las Instrucciones de instalación antes de proceder con la instalación del equipo. En concreto, deberá leer detenidamente la sección "¡IMPORTANTE!" situada al principio de la página. En este folleto se describen principalmente las cuestiones relacionadas con la seguridad y reglamentarias. Si desea consultar explicaciones relativas a la instalación, escanee el código de barras 2D de matriz y consulte los manuales detallados. Panasonic no aceptará responsabilidad alguna derivada de accidentes o daños resultantes de una instalación inadecuada realizada de formas no descritas en los manuales detallados. Además, la garantía del producto no incluye los fallos de funcionamiento ocasionados por una instalación incorrecta.

DEUTSCH

Lesen Sie die Installationsanleitung, bevor Sie mit der Installation beginnen. Insbesondere die Hinweise im Abschnitt „WICHTIG!“ oben auf der Seite müssen unbedingt gelesen werden. Diese Broschüre beschreibt hauptsächlich sicherheitsrelevante und regulatorische Angelegenheiten. Für Erläuterungen, die die Installation betreffen, scannen Sie bitte den Matrix-2D-Barcode und beziehen sich auf die detaillierten Handbücher. Panasonic übernimmt keinerlei Haftung für irgendwelche Unfälle oder Schäden, die durch eine unsachgemäße Installation auf eine nicht in den detaillierten Handbüchern beschriebene Weise verursacht werden. Auch Funktionsstörungen, die durch eine falsche Installation verursacht werden, sind nicht von der Produktgarantie abgedeckt.

ITALIANO

Leggere le Istruzioni di installazione prima di procedere con l'installazione. Prestare particolare attenzione alla sezione "IMPORTANTE!" all'inizio della pagina. Questo opuscolo descrive principalmente argomenti inerenti la sicurezza e normativi. Per le spiegazioni riguardanti l'installazione, scansionare il codice a barre 2D a matrice e fare riferimento ai manuali dettagliati. Panasonic declina ogni responsabilità per incidenti o danni derivanti da un'installazione inadeguata, eseguita diversamente da come descritto nei manuali dettagliati. I malfunzionamenti causati da un'installazione errata inoltre non sono coperti dalla garanzia.

NEDERLANDS

Lees de installatie-instructies zorgvuldig door voor u begint met de installatie. U moet vooral het gedeelte waar "BELANGRIJK!" boven staat heel goed lezen. Dit boekwerkje beschrijft voornamelijk zaken die te maken hebben met de veiligheid en met regelgeving. Voor uitleg over de installatie kunt u de matrix 2D-streepjescode scannen en dan de gedetailleerde handleidingen raadplegen. Panasonic aanvaardt geen enkele aansprakelijkheid voor enig ongeval of enige schade als gevolg van een ondeugdelijke installatie die is uitgevoerd op een manier die niet wordt beschreven in de gedetailleerde handleidingen. Ook worden storingen veroorzaakt door een incorrecte installatie niet gedekt door de garantie op het product.

PORTUGUÊS

Leia atentamente as Instruções de instalação antes de prosseguir com a instalação. Em particular, é necessário ler as informações na secção "IMPORTANTE!" na parte superior da página. Este manual descreve principalmente as questões regulatórias e relacionadas com a segurança. Para as explicações sobre a instalação, digitalize o código de barras 2D em matriz e consulte os manuais detalhados. A Panasonic não assume nenhuma responsabilidade por quaisquer acidentes ou danos resultantes de uma instalação inadequada realizada de uma maneira não descrita nos manuais detalhados. Além disso, um mau funcionamento causado por uma instalação incorrecta não é coberto pela garantia do produto.

ΕΛΛΗΝΙΚΑ

Διαβάστε τις Οδηγίες εγκατάστασης πριν συνεχίσετε με την εγκατάσταση. Συγκεκριμένα, θα χρειαστεί να διαβάσετε την ενότητα «ΣΗΜΑΝΤΙΚΟ!» στο πάνω μέρος της σελίδας. Αυτό το φυλλάδιο περιγράφει κυρίως θέματα που αφορούν την ασφάλεια και τους κανονισμούς. Για εξηγήσεις που αφορούν την εγκατάσταση, σαρώστε τον γραμμωτό κώδικα 2D μήτρας και ανατρέξτε στα αναλυτικά εγχειρίδια. Η Panasonic δεν αποδέχεται καμία ευθύνη για τυχόν ατύχημα ή ζημιά που συμβαίνει ως αποτέλεσμα λανθασμένης εγκατάστασης που εκτελέστηκε με οποιονδήποτε τρόπο δεν περιγράφεται στα αναλυτικά εγχειρίδια. Επίσης, τυχόν δυσλειτουργία που προκαλείται από λανθασμένη εγκατάσταση δεν καλύπτεται από την εγγύηση του προϊόντος.

БЪЛГАРСКИ

Прочетете Ръководството за монтаж, преди да продължите с монтажа. По-точно трябва да прочетете раздел „ВАЖНО!“ в горната част на страницата. Тази брошура описва главно въпросите, свързани със сигурността и регулаторните изисквания. За обяснения относно монтажа, моля, сканирайте 2D баркода на матрицата и направете справка в подробните ръководства. Panasonic не поема никаква отговорност по никакъв начин за каквато и да е злополука или повреда, която може да се случи в резултат от неправилно извършен монтаж и не е описан в подробните ръководства. Авария, причинена от неправилен монтаж не се покрива от гаранцията на продукта.

TÜRKÇE

Montaja devam etmeden önce Montaj Talimatlarını dikkatlice okuyun. Özellikle, sayfanın üstünde verilen "ÖNEMLİ!" bölümü altında verilen bilgileri okumanız gerekir. Bu kitapçıkta temel olarak güvenlikle ilgili bilgiler ve mevzuat bilgileri açıklanmıştır. Kurulum ile ilgili açıklamalar için lütfen matris 2D barkotunu okutun ve ayrıntılı kılavuzlara bakın. Panasonic, ayrıntılı kılavuzlarda açıklanmayan şekilde gerçekleştirilen, yanlış yapılan kurulumlar neticesinde ortaya çıkacak kazalar ve hasarlar ile ilgili hiçbir sorumluluk kabul etmeyecektir. Ayrıca, yanlış kurulumdan kaynaklanan arızalar da ürün garantisini kapsamına girmeyecektir.

IMPORTANT! Please Read Before Starting

This air conditioner must be installed by the sales dealer or installer.
This information is provided for use only by authorized persons.

For safe installation and trouble-free operation, you must:

- This Installation Instructions is for the indoor unit and read the Installation Instructions of the outdoor unit as well.
- Carefully read this instruction booklet before beginning.
- This air conditioner is required to have the remote controller which is adaptable to nanoe™ X function.
- Follow each installation or repair step exactly as shown.
- This air conditioner shall be installed in accordance with National Wiring Regulations.
- That compliance with national gas regulations shall be observed.
- The product meets the technical requirements of EN/IEC 61000-3-3.

WARNING

- Do not use means to accelerate the defrosting process or to clean, other than those recommended by the manufacturer.
- The appliance shall be stored in a room without continuously operating ignition sources (for example: open flames, an operating gas appliance or an operating electric heater).
- Do not pierce or burn.
- Be aware that refrigerants may not contain an odour.
- The following checks shall be applied to installations using flammable refrigerants.
Appliance shall be installed, operated and stored in a room with a floor area larger than $[A_{min}] \text{ m}^2$.
As for $[A_{min}]$, see Section "CHECK OF DENSITY LIMIT".

SPECIAL PRECAUTIONS

WARNING When Wiring



ELECTRICAL SHOCK CAN CAUSE SEVERE PERSONAL INJURY OR DEATH. ONLY A QUALIFIED, EXPERIENCED ELECTRICIAN SHOULD ATTEMPT TO WIRE THIS SYSTEM.

- Do not supply power to the unit until all wiring and tubing are completed or reconnected and checked.
- Highly dangerous electrical voltages are used in this system. Carefully refer to the wiring diagram and these instructions when wiring. Improper connections and inadequate grounding can cause **accidental injury or death**.
- Connect all wiring tightly. Loose wiring may cause overheating at connection points and a possible fire hazard.
- Provide a power outlet to be used exclusively for each unit.
- Provide a power outlet exclusively for each unit, and full disconnection means having a contact separation by 3 mm in all poles must be incorporated in the fixed wiring in accordance with the wiring rules.
- To prevent possible hazards from insulation failure, the unit must be grounded. 

- Pay close attention to all warning and caution notices given in this manual.



WARNING

This symbol refers to a hazard or unsafe practice which can result in severe personal injury or death.



CAUTION

This symbol refers to a hazard or unsafe practice which can result in personal injury or product or property damage.

If Necessary, Get Help

These instructions are all you need for most installation sites and maintenance conditions. If you require help for a special problem, contact our sales/service outlet or your certified dealer for additional instructions.

In Case of Improper Installation

The manufacturer shall in no way be responsible for improper installation or maintenance service, including failure to follow the instructions in this document.

- Check that cabling will not be subject to wear, corrosion, excessive pressure, vibration, sharp edges or any other adverse environmental effects.
The check shall also take into account the effects of aging or continual vibration from sources such as compressors or fans.
- This equipment is strongly recommended to be installed with Earth Leakage Circuit Breaker (ELCB) or Residual Current Device (RCD). Otherwise, it may cause electrical shock and fire in case of equipment breakdown or insulation breakdown.

When Transporting

- It may need two or more people to carry out the installation work.
- Be careful when picking up and moving the indoor and outdoor units. Get a partner to help, and bend your knees when lifting to reduce strain on your back. Sharp edges or thin aluminum fins on the air conditioner can cut your fingers.

When Storing...



WARNING

- The appliance shall be stored in a well-ventilated area where the room size corresponds to the room area as specified for operation.
- The appliance shall be stored in a room without continuously operating open flames (for example: an operating gas appliance) and ignition sources (for example: an operating electric heater).
- The appliance shall be stored so as to prevent mechanical damage from occurring.

When Installing...

- Select an installation location which is rigid and strong enough to support or hold the unit, and select a location for easy maintenance.
- In cases that require mechanical ventilation, ventilation openings shall be kept clear of obstruction.
- An unventilated area where the appliance using flammable refrigerants is installed shall be so constructed that should any refrigerant leak, it will not stagnate so as to create a fire or explosion hazard.

...In a Room

Properly insulate any tubing run inside a room to prevent “sweating” that can cause dripping and water damage to walls and floors.



CAUTION

Keep the fire alarm and the air outlet at least 1.5 m away from the unit.

...In Moist or Uneven Locations

Use a raised concrete pad or concrete blocks to provide a solid, level foundation for the outdoor unit. This prevents water damage and abnormal vibration.

...In an Area with High Winds

Securely anchor the outdoor unit down with bolts and a metal frame. Provide a suitable air baffle.

...In a Snowy Area (for Heat Pump-type Systems)

Install the outdoor unit on a raised platform that is higher than drifting snow. Provide snow vents.

...At least 2.2 m

Installation height for indoor unit shall be at least 2.2 m.

...In laundry rooms

Do not install in laundry rooms. Indoor unit is not drip proof.

When Connecting Refrigerant Tubing

Pay particular attention to refrigerant leakages.



WARNING

- When performing piping work, do not mix air except for specified refrigerant in refrigeration cycle. It causes capacity down, and risk of explosion and injury due to high tension inside the refrigerant cycle.
- If the refrigerant comes in contact with a flame, it produces a toxic gas.
- Do not add or replace refrigerant other than specified type. It may cause product damage, burst and injury, etc.
- Ventilate the room immediately in the event of a refrigerant gas leakage during installation. Be careful not to allow contact of the refrigerant gas with a flame as this will cause the generation of toxic gas.
- Keep all tubing runs as short as possible.
- Use the flare method for connecting tubing.
- Apply refrigerant lubricant to the matching surfaces of the flare and union tubes before connecting them, then tighten the nut with a torque wrench for a leak-free connection.
- Check carefully for leaks before starting the test run.
- Do not leak refrigerant while piping work for an installation or re-installation, and while repairing refrigeration parts.
Handle liquid refrigerant carefully as it may cause frostbite.
- Under no circumstances shall potential sources of ignition be used in the searching or detection of refrigerant leaks.
- A halide torch (or any other detector using a naked flame) shall not be used.
- Electronic leak detectors may be used to detect refrigerant leaks but, the sensitivity may not be adequate, or may need re-calibration. (Detection equipment shall be calibrated in a refrigerant-free area.)
- Ensure that the detector is not a potential source of ignition and is suitable for the refrigerant used.
- Leak detection equipment shall be set at a percentage of the lower flammable limit (LFL) of the refrigerant and shall be calibrated to the refrigerant employed and the appropriate percentage of gas (25% maximum) is confirmed.
- Leak detection fluids are suitable for use with most refrigerants but the use of detergents containing chlorine shall be avoided as the chlorine may react with the refrigerant and corrode the copper pipe-work.
- If a leak is suspected, all naked flames shall be removed/extinguished.
- If a leakage of refrigerant is found which requires brazing, all of the refrigerant shall be recovered from the system, or isolated (by means of shut off valves) in a part of the system remote from the leak. Oxygen free nitrogen (OFN) shall then be purged through the system both before and during the brazing process.

When Servicing

- Contact the sales dealer or service dealer for a repair.
- Be sure to turn off the power before servicing.
- Turn the power OFF at the main power box (mains), wait at least 5 minutes until it is discharged, then open the unit to check or repair electrical parts and wiring. 
- Keep your fingers and clothing away from any moving parts.
- Clean up the site after you finish, remembering to check that no metal scraps or bits of wiring have been left inside the unit.

WARNING

- This product must not be modified or disassembled under any circumstances. Modified or disassembled unit may cause fire, electric shock or injury.
- Do not clean inside the indoor and outdoor units by users. Engage authorized dealer or specialist for cleaning.
- In case of malfunction of this appliance, do not repair by yourself. Contact the sales dealer or service dealer for a repair and disposal.

CAUTION

- Ventilate any enclosed areas when installing or testing the refrigeration system. Leaked refrigerant gas, on contact with fire or heat, can produce dangerously toxic gas.
- Confirm after installation that no refrigerant gas is leaking. If the gas comes in contact with a burning stove, gas water heater, electric room heater or other heat source, it can cause the generation of toxic gas.

Others

When disposal of the product, do follow the precautions referring to Section “Recovery” in the installation instructions supplied with the outdoor unit and comply with national regulations.

WARNING

- Do not sit or step on the unit. You may fall down accidentally.



CAUTION

- Do not touch the air inlet or the sharp aluminum fins of the outdoor unit. You may get injured.
- Do not stick any object into the FAN CASE. You may be injured and the unit may be damaged.



SERVICING

CAUTION

- Any qualified person who is involved with working on or breaking into a refrigerant circuit should hold a current valid certificate from an industry-accredited assessment authority, which authorizes their competence to handle refrigerants safely in accordance with an industry recognised assessment specification.
 - Servicing shall only be performed as recommended by the equipment manufacturer. Maintenance and repair requiring the assistance of other skilled personnel shall be carried out under the supervision of the person competent in the use of flammable refrigerants.
 - Servicing shall be performed only as recommended by the manufacturer.
 - Prior to beginning work on systems containing flammable refrigerants, safety checks are necessary to ensure that the risk of ignition is minimised. For repair to the refrigerating system, (2) to (6) shall be completed prior to conducting work on the system.
- (1) Work shall be undertaken under a controlled procedure so as to minimise the risk of a flammable gas or vapour being present while the work is being performed.
 - (2) All maintenance staff and others working in the local area shall be instructed on the nature of work being carried out. Work in confined spaces shall be avoided. The area around the workspace shall be sectioned off. Ensure that the conditions within the area have been made safe by control of flammable material.
 - (3) The area shall be checked with an appropriate refrigerant detector prior to and during work, to ensure the technician is aware of potentially toxic or flammable atmospheres. Ensure that the leak detection equipment being used is suitable for use with all applicable refrigerants, i.e. non-sparking, adequately sealed or intrinsically safe.
 - (4) If any hot work is to be conducted on the refrigerating equipment or any associated parts, appropriate fire extinguishing equipment shall be available to hand. Have a dry powder or CO₂ fire extinguisher adjacent to the charging area.
 - (5) No person carrying out work in relation to a refrigerating system which involves exposing any pipe work shall use any sources of ignition in such a manner that it may lead to the risk of fire or explosion. All possible ignition sources, including cigarette smoking, should be kept sufficiently far away from the site of installation, repairing, removing and disposal, during which refrigerant can possibly be released to the surrounding space. Prior to work taking place, the area around the equipment is to be surveyed to make sure that there are no flammable hazards or ignition risks. “No Smoking” signs shall be displayed.
 - (6) Ensure that the area is in the open or that it is adequately ventilated before breaking into the system or conducting any hot work. A degree of ventilation shall continue during the period that the work is carried out. The ventilation should safely disperse any released refrigerant and preferably expel it externally into the atmosphere.
 - (7) Where electrical components are being changed, they shall be fit for the purpose and to the correct specification. At all times the manufacturer’s maintenance and service guidelines shall be followed. If in doubt, consult the manufacturer’s technical department for assistance.
 - The actual refrigerant charge is in accordance with the room size within which the refrigerant containing parts are installed.
 - The ventilation machinery and outlets are operating adequately and are not obstructed.

- Marking to the equipment continues to be visible and legible. Markings and signs that are illegible shall be corrected.
 - Refrigerating pipe or components are installed in a position where they are unlikely to be exposed to any substance which may corrode refrigerant containing components, unless the components are constructed of materials which are inherently resistant to being corroded or are suitably protected against being so corroded.
- (8) Repair and maintenance to electrical components shall include initial safety checks and component inspection procedures. If a fault exists that could compromise safety, then no electrical supply shall be connected to the circuit until it is satisfactorily dealt with. If the fault cannot be corrected immediately but it is necessary to continue operation, an adequate temporary solution shall be used. This shall be reported to the owner of the equipment so all parties are advised. Initial safety checks shall include:
- That capacitors are discharged. This shall be done in a safe manner to avoid possibility of sparking.
 - That no live electrical components and wiring are exposed while charging, recovering or purging the system.
 - That there is continuity of earth bonding.
- During repairs to sealed components, all electrical supplies shall be disconnected from the equipment being worked upon prior to any removal of sealed covers, etc.
 - Particular attention shall be paid to the following to ensure that by working on electrical components, the casing is not altered in such a way that the level of protection is affected. This shall include damage to cables, excessive number of connections, terminals not made to original specification, damage to seals, incorrect fitting of glands, etc.
 - Ensure that apparatus is mounted securely.
 - Ensure that seals or sealing materials have not degraded such that they no longer serve the purpose of preventing the ingress of flammable atmospheres.
 - Replacement parts shall be in accordance with the manufacturer's specifications.

NOTE:

The use of silicon sealant may inhibit the effectiveness of some types of leak detection equipment. Intrinsically safe components do not have to be isolated prior to working on them.

- Do not apply any permanent inductive or capacitance loads to the circuit without ensuring that this will not exceed the permissible voltage and current permitted for the equipment in use.
- Intrinsically safe components are the only types that can be worked on while live in the presence of a flammable atmosphere.
- The test apparatus shall be at the correct rating.
- Replace components only with parts specified by the manufacturer. Unspecified parts by manufacturer may result ignition of refrigerant in the atmosphere from a leak.

REMOVAL AND EVACUATION



CAUTION

- When breaking into the refrigerant circuit to make repairs – or for any other purpose – conventional procedures shall be used.
However, it is important that best practice is followed since flammability is a consideration.
The following procedure shall be adhered to:
 - Remove refrigerant.
 - Purge the circuit with inert gas.
 - Evacuate.
 - Purge again with inert gas.
 - Open the circuit by cutting or brazing.
- The refrigerant charge shall be recovered into the correct recovery cylinders.
- The system shall be “flushed” with Oxygen free nitrogen (OFN) to render the unit safe.
- This process may need to be repeated several times.
- Compressed air or oxygen shall not be used for this task.
- Flushing shall be achieved by breaking the vacuum in the system with OFN and continuing to fill until the working pressure is achieved, then venting to atmosphere, and finally pulling down to a vacuum.
- This process shall be repeated until no refrigerant is within the system.
- When the final OFN charge is used, the system shall be vented down to atmospheric pressure to enable work to take place.
- This operation is absolutely vital if brazing operations on the pipe work are to take place.
- Ensure that the outlet for the vacuum pump is not close to any potential ignition sources and there is ventilation available.

CHARGING PROCEDURES

NOTE:

Refer to the Installation Instructions attached to the outdoor unit.

DECOMMISSIONING



CAUTION

- Before carrying out this procedure, it is essential that the technician is completely familiar with the equipment and all its details.
- It is recommended good practice that all refrigerants are recovered safely.
- Prior to the task being carried out, an oil and refrigerant sample shall be taken in case analysis is required prior to re-use of recovered refrigerant.
- It is essential that electrical power is available before the task is commenced.
 - a) Become familiar with the equipment and its operation.
 - b) Isolate system electrically.
 - c) Before attempting the procedure ensure that:
 - Mechanical handling equipment is available, if required, for handling refrigerant cylinders.
 - All personal protective equipment is available and being used correctly.
 - The recovery process is supervised at all times by a competent person.

- Recovery equipment and cylinders conform to the appropriate standards.
- d) Pump down refrigerant system, if possible.
- e) If a vacuum is not possible, make a manifold so that refrigerant can be removed from various parts of the system.
- f) Make sure that cylinder is situated on the scales before recovery takes place.
- g) Start the recovery machine and operate in accordance with instructions.
- h) Do not overfill cylinders. (No more than 80% volume liquid charge).
- i) Do not exceed the maximum working pressure of the cylinder, even temporarily.
- j) When the cylinders have been filled correctly and the process completed, make sure that the cylinders and the equipment are removed from site promptly and all isolation valves on the equipment are closed off.
- k) Recovered refrigerant shall not be charged into another refrigerating system unless it has been cleaned and checked.
- Electrostatic charge may accumulate and create a hazardous condition when charging or discharging the refrigerant.
To avoid fire or explosion, dissipate static electricity during transfer by grounding and bonding containers and equipment before charging / discharging.

RECOVERY

NOTE:

Refer to the Installation Instructions attached to the outdoor unit.

NOTICE

The English text is the original instructions. Other languages are translations of the original instructions.





Important Information Regarding The Refrigerant Used

NOTE

Refer to the Installation Instructions attached to the outdoor unit.

GENERAL

This booklet briefly outlines where and how to install the air conditioning system. Please read over the entire set of instructions for the indoor and outdoor units and make sure all accessory parts listed are with the system before beginning. The installation of pipe-work shall be kept to a minimum.

| | | |
|---|----------------|--|
|  | WARNING | This symbol shows that this equipment uses a flammable refrigerant. If the refrigerant is leaked, together with an external ignition source, there is a possibility of ignition. |
|  | CAUTION | This symbol shows type of flammable refrigerant contained in the system. |
|  | CAUTION | This symbol shows that the Operating Instructions should be read carefully. |
|  | CAUTION | This symbol shows that a service personnel should be handling this equipment with reference to the Technical Manual. |
|  | CAUTION | This symbol shows that there is information included in the Operating Instructions and/or Installation Instructions. |

HOW TO INSTALL THE INDOOR UNIT

Fix the suspension bolts securely in the ceiling by attaching them to the ceiling support structure, or by any other method that ensures that the unit will be securely and safely suspended.

ELECTRICAL WIRING

1. General Precautions on Wiring

- (1) Before wiring, confirm the rated voltage of the unit as shown on its nameplate, then carry out the wiring closely following the wiring diagram under Section 3.



- (2) This equipment is strongly recommended to be installed with Earth Leakage Circuit Breaker (ELCB) or Residual Current Device (RCD). Otherwise, it may cause electrical shock and fire in case of equipment breakdown or insulation breakdown. The ELCB must be incorporated in the fixed wiring in accordance with the wiring regulations. The ELCB must be an approved circuit capacity, having a contact separation in all poles. The ELCB or RCD suitable for use with inverters, resistant to high frequency noise, is most suitable. The ELCB's or RCD's intended for protection to include high frequency currents are unnecessary and should be avoided, as potentially causing nuisance tripping, in this application.
- (3) To prevent possible hazards from insulation failure, the unit must be grounded.
- (4) Each wiring connection must be done in accordance with the wiring system diagram. Wrong wiring may cause the unit to misoperate or become damaged.
- (5) Do not allow wiring to touch the refrigerant tubing, compressor, or any moving parts of the fan.
- (6) Unauthorized changes in the internal wiring can be very dangerous. The manufacturer will accept no responsibility for any damage or misoperation that occurs as a result of such unauthorized changes.

- (7) Regulations on wire diameters differ from locality to locality. For field wiring rules, please refer to your LOCAL ELECTRICAL CODES before beginning. You must ensure that installation complies with all relevant rules and regulations.

- (8) To prevent malfunction of the air conditioner caused by electrical noise, care must be taken when wiring as follows:

- The remote control wiring and the inter-unit control wiring should be wired apart from the inter-unit power wiring.
- Use shielded wires for inter-unit control wiring between units and ground the shield on both sides.



CAUTION
Check local electrical codes and regulations before wiring. Also, check any specified instruction or limitations.

2. Wire Length and Wire Diameter for Power Supply System

Connection cable between outdoor and indoor unit has 2 types; One is 2-line connection and the other is 3-line connection. Check the type of the outdoor unit terminal board as illustrated below and make connection.

- If U1 and U2 are shown on the terminal board, it is for 2-line connection.
- If 1, 2 and 3 are shown on the terminal board, it is for 3-line connection.

* See the example in Section 3.

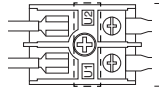

Inter-unit (between outdoor and indoor units) control wiring

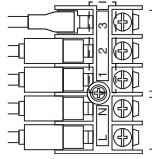

Power supply connection cable between outdoor and indoor unit

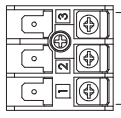

Connection cable between outdoor and indoor unit

Indoor unit

(Type of 2-line connection [U1, U2] with indoor and outdoor units)

| | | |
|------|---|-------------------------------------|
| Type | (B) Power supply cable | Time delay fuse or circuit capacity |
| T3 | Min. 2.5 mm ² *1 Max. 130 m | 15 A |

Indoor unit

(Type of 3-line connection [1, 2 and 3] with indoor and outdoor units)

| | | |
|------|---|-------------------------------------|
| Type | (B) Power supply cable | Time delay fuse or circuit capacity |
| T3 | Min. 2.5 mm ² *1 Max. 130 m | 15 A |

| | | |
|------|--|--|
| Type | Connection cable between outdoor and indoor unit | |
| T3 | (F) Outdoor unit U-36 ~ 71PZ3E5 Min. 1.5 mm ² *1 Max. 40 m | (G) For the outdoor units other than shown on the left, refer to the installation instructions of the outdoor units. |

Control wiring

| | | |
|--|---|---|
| (C) Inter-unit (between outdoor and indoor units) control wiring | (D) Remote control wiring | (E) Remote control wiring for group control |
| Min. 0.75 mm ² Max. 1,000 m | Min. 0.75 mm ² (D) + (E) : Max. 500 m (E) : Max. 200 m The above descriptions can be used for the model CZ-RTC4 or CZ-RTC5B. For other remote controllers, refer to the manual of each unit. | Min. 0.75 mm ² |
| Use shielded wiring*2 | | |

NOTE

*1 Maximum applicable wire for terminal board of indoor unit : 4 mm²

*2 With ring-type wire terminal

- In the case of 3-line connection, connection cable between outdoor and indoor unit shall be approved polychloroprene sheathed flexible cord. Type designation 60245 IEC57 (H05RN-F, GP85PCP etc.) or heavier cord.
- Use the standard power supply cables for Europe (such as H05RN-F or H07RN-F which conform to CENELEC (HAR) rating specifications) or use the cables based on IEC standard. (60245 IEC57, 60245 IEC66)

3. Wiring System Diagrams

2-LINE CONNECTION

Example : Twin connection

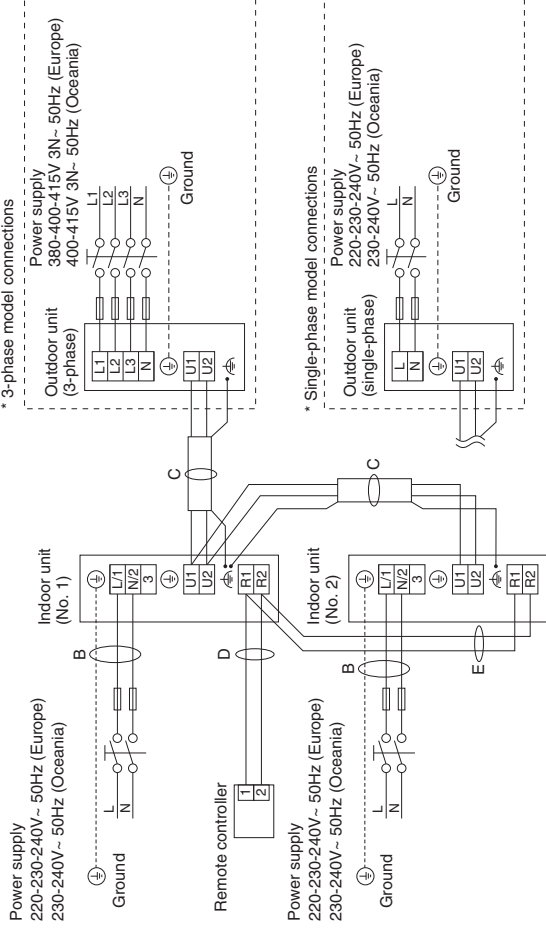

Indoor unit (No. 1) wiring sample

Use this screw when connecting the shield for the inter-unit control wiring to ground.

(⚡) : Functional earthing

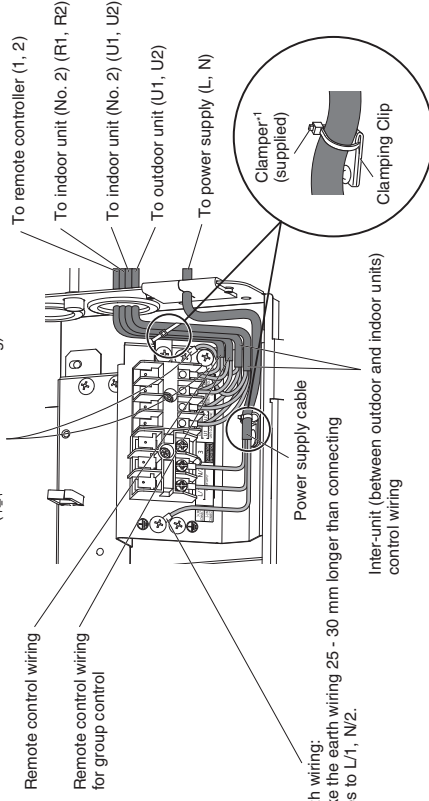

Earth wiring:
Make the earth wiring 25 - 30 mm longer than connecting wires to L1, N/2.

Inter-unit (between outdoor and indoor units) control wiring

*1 Fasten tightly.

■ 3-LINE CONNECTION

Example : Twin connection

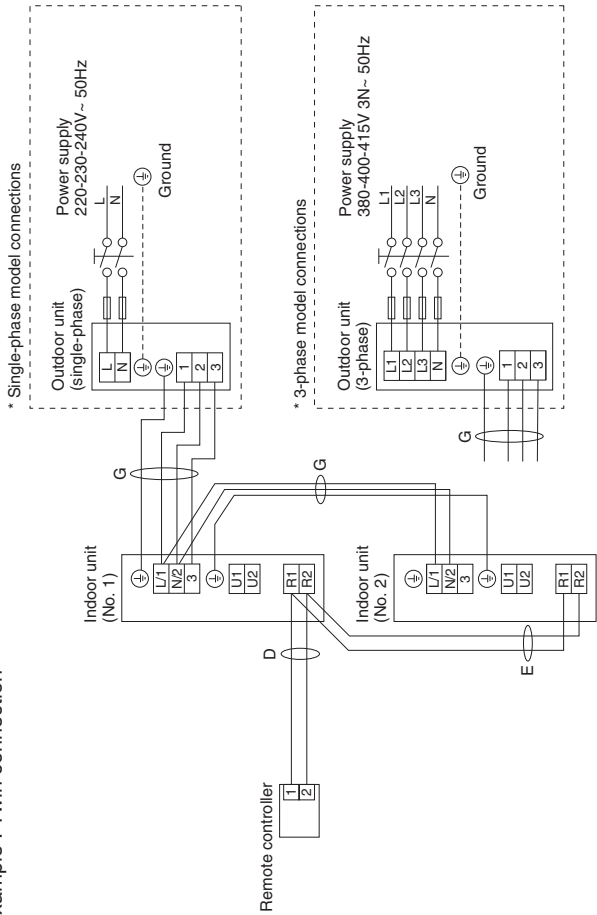

Indoor unit (No. 1) wiring sample

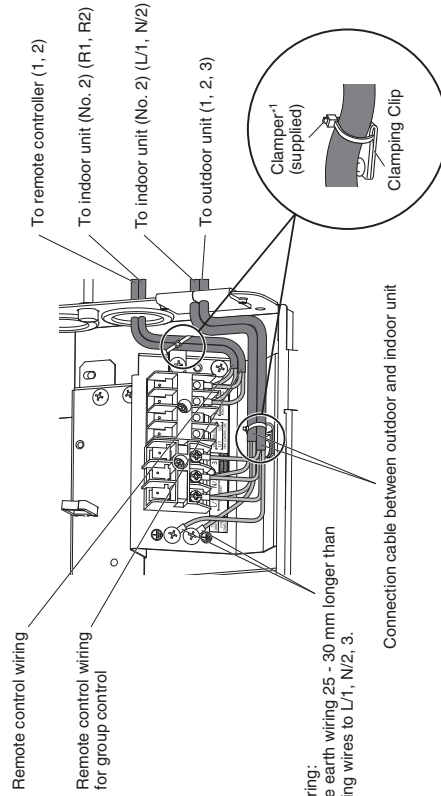

Earth wiring:
Make the earth wiring 25 - 30 mm longer than connecting wires to L1, N/2, 3.

*1 Fasten tightly.

HOW TO PROCESS TUBING

Must ensure mechanical connections be accessible for maintenance purposes.

1. Connecting the Refrigerant Tubing

Use of the Flaring Method

Many of conventional split system air conditioners employ the flaring method to connect refrigerant tubes that run between indoor and outdoor units. In this method, the copper tubes are flared at each end and connected with flare nuts.

NOTE

When flared joints are reused, the flare part shall be re-fabricated.

A good flare should have the following characteristics:

- inside surface is glossy and smooth
- edge is smooth
- tapered sides are of uniform length

Caution Before Connecting Tubes Tightly

(1) Apply a sealing cap or water-proof tape to prevent dust or water from entering the tubes before they are used.

(2) Be sure to apply refrigerant lubricant (ether oil) to the inside of the flare nut before making piping connections. This is effective for reducing gas leaks.

(3) For proper connection, align the union tube and flare tube straight with each other, then screw on the flare nut lightly at first to obtain a smooth match.

● Adjust the shape of the liquid tube using a tube bender at the installation site and connect it to the liquid tubing side valve using a flare.

2. Connecting Tubing Between Indoor and Outdoor Units

Tightly connect the indoor-side refrigerant tubing extended from the wall with the outdoor-side tubing.

Indoor Unit Tubing Connection

| Indoor unit type | S-3650PT3E | S-6071PT3E | S-1014PT3E |
|------------------|------------|----------------|------------|
| Gas tube | ø12.7 | ø15.88 (ø12.7) | ø15.88 |
| Liquid tube | ø6.35 | ø9.52 (ø6.35) | ø9.52 |

Unit : mm

Different-diameter-tube joint for the indoor unit tubing connection part is supplied with S-6071PT3E.

The size of parenthesis indicates the connection tube diameter when using the different-diameter-tube joint.

- (1) When using with single connection
- Outdoor PZ3 series (Type 60)

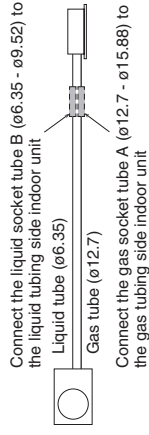

- Outdoor PZ3 series (Type 71)

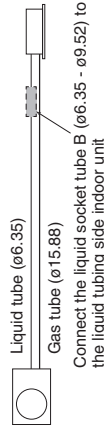

The outdoor PZ2 and PZH2 series do not use the different-diameter-tube joint.

3. Insulating the Refrigerant Tubing

Tubing Insulation

Must ensure that pipe-work shall be protected from physical damage.

- Thermal insulation must be applied to all units tubing, including distribution joint (field supply).
- * For gas tubing, the insulation material must be heat resistant to 120°C or above. For other tubing, it must be heat resistant to 80°C or above.

Insulation material thickness must be 10 mm or greater. If the conditions inside the ceiling exceed DB 30°C and RH 70%, increase the thickness of the gas tubing insulation material by 1 step.

Two tubes arranged together

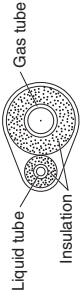

CAUTION

If the exterior of the outdoor unit valves has been finished with a square duct covering, make sure you allow sufficient space to access the valves and to allow the panels to be attached and removed.

Insulation of the flare nuts

Attach the flare insulator (supplied) just like wrapping around the flare nut (supplied). Match the both slits of flare insulators for gas and liquid tubes facing upward. Tightly attach the end of the flare insulators to the tube cradle without any space. Then clamp the flare insulator with the clampers about 20 mm away from both ends.

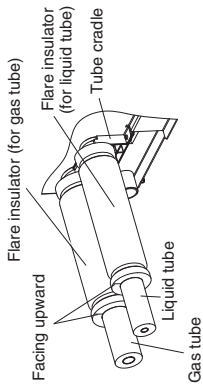

Additional Precautions For R32 Models

- 1 Ensure to do the re-flaring of pipes before connecting to units to avoid leaking.

To prevent the ingress of moisture into the joint which could have the potential to freeze and then cause leakage, the joint must be sealed with suitable silicone and insulation material. The joint should be sealed on both liquid and gas side.

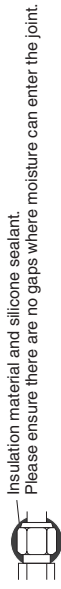

Silicone Sealant must be neutral cure and ammonia free. Use of silicone containing ammonia can lead to stress corrosion on the joint and cause leakage.

Taping the flare nuts

Wind the white insulating tape around the flare nuts at the gas tube connections. Then cover up the tubing connections with the flare insulator, and fill the gap at the union with the supplied black insulating tape. Finally, fasten the insulator at both ends with the supplied vinyl clamps.

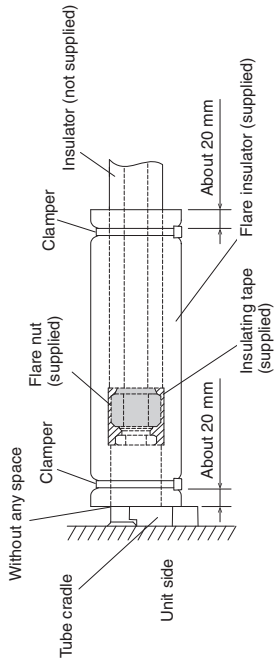

NOTE

Tighten the clampers to prevent any condensation that may occur as the copper tubing is exposed.

* Illustration shows when using by S-6071PT3E. (Only PZ3 series)

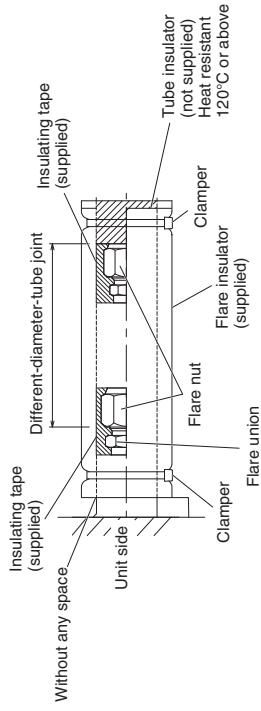

Insulation material

The material used for insulation must have good insulation characteristics, be easy to use, be age resistant, and must not easily absorb moisture.

NOTE

If noise bothers you from the area between indoor and outdoor units' connection pipes, it is effective to wind the soundproofing materials (field supply) to reduce noise.

CAUTION

After a tube has been insulated, never try to bend it into a narrow curve because it can cause the tube to break or crack.

Never grasp the drain or refrigerant connecting outlets when moving the unit.

TEST RUN : Address Setting

NOTE

The displays of the earth, outdoor unit power supply wiring and earth leakage circuit breaker are omitted.

Basic connection 1 : Single type and simultaneous multiple operations

2-LINE CONNECTION

- **Simultaneous multiple operations: It is possible to operate maximum 4 (double-twin) indoor units within one outdoor unit.**
(Only specified indoor unit combination. Independent operation is not possible by connecting an individual remote controller.)
- It is not necessary to make setting of the refrigerant system address.
- When turning on all indoor and outdoor units, the auto address will start. It takes maximum 10 minutes. LED1 and LED2 of outdoor unit control PCB blink alternately during auto address setting.
- When finished, LEDs go off.
- When the auto address setting is completed, wait at least 1 minute and 30 seconds. Then start the operation.

Single type

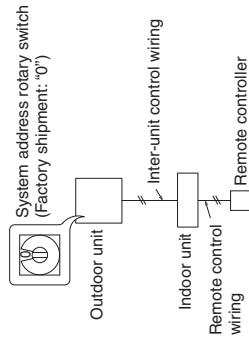

Simultaneous multiple (double-twin) operations

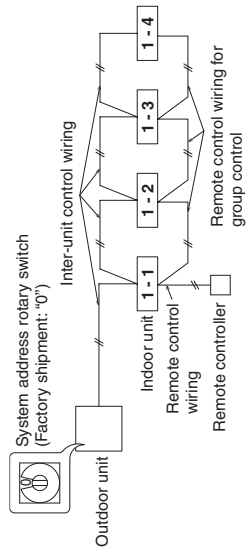

3-LINE CONNECTION

- **Simultaneous multiple operations: It is possible to operate maximum 4 (double-twin) indoor units within one outdoor unit.**
(Only specified indoor unit combination. Independent operation is not possible by connecting an individual remote controller.)
- It is not necessary to make setting of the refrigerant system address.
- When turning on all indoor and outdoor units, the auto address will start. It takes maximum 10 minutes.
- When the auto address setting is completed, wait at least 1 minute and 30 seconds. Then start the operation.

Single type

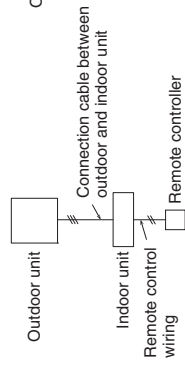

Simultaneous multiple (double-twin) operations

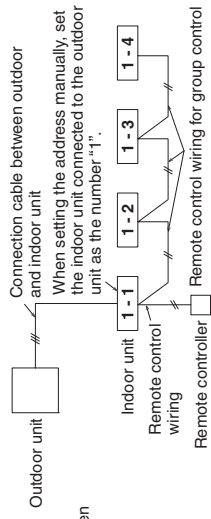

CHECK OF DENSITY LIMIT

The refrigerant (R32), which is used in the air conditioner, is a flammable refrigerant. So the requirements for installation space of appliance are determined according to the refrigerant charge amount $[m_c]$ used in the appliance.

Regarding the refrigerant charge amount $[m_c]$ used in the appliance, refer to the installation instructions for the outdoor unit.

The minimum indoor floor space compared with the amount of refrigerant is roughly as follows:

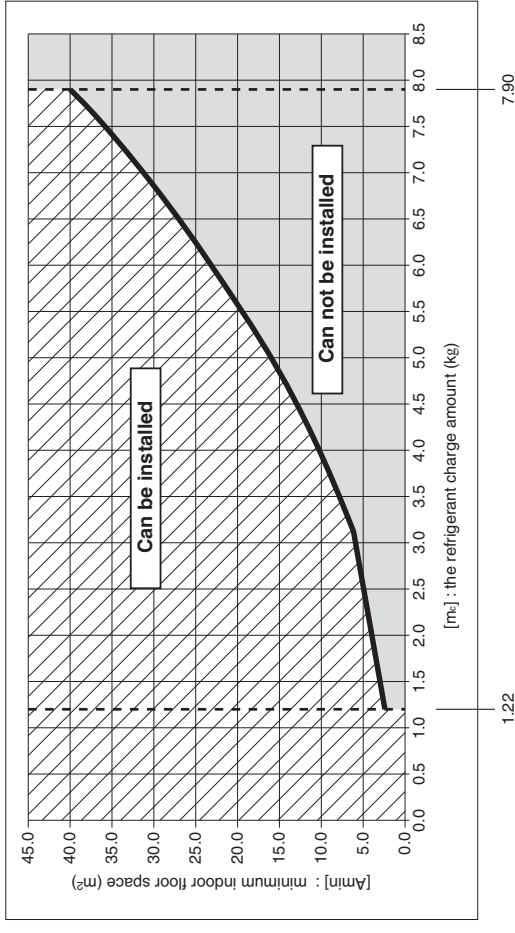

$[m_c]$: The refrigerant charge amount (kg) (Total of refrigerant at shipment and refrigerant charge amount in the field).

$[Amin]$: Minimum indoor floor space (m²)

| $[m_c]$ | $[Amin]$ |
|---------|----------|
| 1.22 | 2.5 |
| 1.3 | 2.6 |
| 1.4 | 2.8 |
| 1.5 | 3.0 |
| 1.6 | 3.2 |
| 1.7 | 3.4 |
| 1.8 | 3.6 |
| 1.9 | 3.8 |
| 2.0 | 4.0 |
| 2.1 | 4.2 |
| 2.2 | 4.4 |
| 2.3 | 4.6 |
| 2.4 | 4.8 |
| 2.5 | 5.0 |
| 2.6 | 5.2 |
| 2.7 | 5.4 |
| 2.8 | 5.6 |

| $[m_c]$ | $[Amin]$ |
|---------|----------|
| 2.9 | 5.8 |
| 3.0 | 6.0 |
| 3.1 | 6.2 |
| 3.2 | 6.5 |
| 3.3 | 6.9 |
| 3.4 | 7.4 |
| 3.5 | 7.8 |
| 3.6 | 8.3 |
| 3.7 | 8.7 |
| 3.8 | 9.2 |
| 3.9 | 9.7 |
| 4.0 | 10.2 |
| 4.1 | 10.7 |
| 4.2 | 11.2 |
| 4.3 | 11.8 |
| 4.4 | 12.3 |
| 4.5 | 12.9 |

| $[m_c]$ | $[Amin]$ |
|---------|----------|
| 4.6 | 13.4 |
| 4.7 | 14.0 |
| 4.8 | 14.6 |
| 4.9 | 15.2 |
| 5.0 | 15.9 |
| 5.1 | 16.5 |
| 5.2 | 17.2 |
| 5.3 | 17.8 |
| 5.4 | 18.5 |
| 5.5 | 19.2 |
| 5.6 | 19.9 |
| 5.7 | 20.6 |
| 5.8 | 21.3 |
| 5.9 | 22.1 |
| 6.0 | 22.8 |
| 6.1 | 23.6 |
| 6.2 | 24.4 |

| $[m_c]$ | $[Amin]$ |
|---------|----------|
| 6.3 | 25.2 |
| 6.4 | 26.0 |
| 6.5 | 26.8 |
| 6.6 | 27.6 |
| 6.7 | 28.5 |
| 6.8 | 29.3 |
| 6.9 | 30.2 |
| 7.0 | 31.1 |
| 7.1 | 32.0 |
| 7.2 | 32.9 |
| 7.3 | 33.8 |
| 7.4 | 34.7 |
| 7.5 | 35.7 |
| 7.6 | 36.6 |
| 7.7 | 37.6 |
| 7.8 | 38.6 |
| 7.9 | 39.6 |